

# P20 series

## Professional 24VAC Camera Housing



P2000-I / P2000-AI



P2000-IW / P2000-AIW



AETEK, a professional camera housing manufacturer, provides a series of rugged outdoor surveillance housings which are compatible with most of today's IP and analog box cameras. The camera housings are constructed from cast aluminum to meet IP66/IP68, and IK10 standards. The housing can even support cameras equipped with wide-angle lenses or long-distant remote focus lenses.

The P20 series supported 24VAC power input are professional models, all of which are equipped with window heater & blower. Additionally, more features such as a side-opening alarm switch, an adjustable sunshield, and an ITB (Illuminator Touch Board) concealing the wiring for optional vari-IR illuminator let the P20 applied onto long-ranged IP surveillance day & night.

Some models also offer a built-in wiper or -40°C cold start.

### Features

- IP66 standard (P2000-IW, P2000-AIW)
- IP68 standard (P2000-I, P2000-AI)
- IK10 impact rated cast aluminum housing
- Heater & blower enable demisting / deicing for window
- Adjustable sunshield
- Side-opening alarm switch
- ITB (Illuminator Touch Board) snaps IR LEDs directly to the housing & conceals the wiring
- Accommodates box cameras equipped with wide-angle lenses & long-distance remote focus lenses (8-80 mm)
- Built-in wiper (P2000-IW, P2000-AIW)
- Camera heater supports cold start at -40°C (P2000-AI, P2000-AIW)



P2000-I Camera housing + VR-481 VAIR LEDs + BK-101 Wall mount bracket concealing cable



AXIS Q1635+ 8 – 80mm varifocal lens

# Specifications

	P2000-I	P2000-AI	P2000-IW	P2000-AIW
<b>Electrical Specifications</b>				
Input Voltage	24VAC	24VAC	24VAC	24VAC
12VDC Output Power Budget	30W	30W	30W	30W
24VAC Output Power Budget	80W	80W	80W	80W
Power Consumption	Window Heater: 10W Blower: 2W Camera: 6 ~ 8W	Window Heater: 10W Cold Start Heater: 30W Blower: 2W Camera: 6 ~ 8W	Window Heater: 10W Blower: 2W Camera: 6 ~ 8W Wiper: 6 W	Window Heater: 10W Cold Start Heater: 30W Blower: 2W Camera: 6 ~ 8W Wiper: 6W
Optional VAIR LEDs Power Consumption	VR-060: 6W VR-120: 12W VR-241: 24W VR-481: 48W	VR-060: 6W VR-120: 12W VR-241: 24W VR-481: 48W	VR-060: 6W VR-120: 12W VR-241: 24W VR-481: 48W	VR-060: 6W VR-120: 12W VR-241: 24W VR-481: 48W
Optional 10L Water Tank & Pump for P2000-IW & P2000-AIW	-	-	TP-100: 12W	TP-100: 12W
<b>Environmental Specifications</b>				
Operating Temperature*	-20°C ~ 65°C (-4°F ~ 149°F) -20°C ~ 50°C (w/IR LEDs)	-50°C ~ 65°C (-58°F ~ 149°F) -50°C ~ 50°C (w/IR LEDs) Cold Startup: -40°C (-40°F)	-20°C ~ 65°C (-4°F ~ 149°F) -20°C ~ 50°C (w/IR LEDs)	-50°C ~ 65°C (-58°F ~ 149°F) -50°C ~ 50°C (w/IR LEDs) Cold Startup: -40°C (-40°F)
Window Heater ON / OFF	≤ 20°C (68°F) ON ≥ 30°C (86°F) OFF	≤ 20°C (68°F) ON ≥ 30°C (86°F) OFF	≤ 20°C (68°F) ON ≥ 30°C (86°F) OFF	≤ 20°C (68°F) ON ≥ 30°C (86°F) OFF
Cold Start Heater ON/OFF	-	≤ 0°C (32°F) ON ≥ 5°C (41°F) OFF	-	≤ 0°C (32°F) ON ≥ 5°C (41°F) OFF
Blower ON / OFF	≥ 35°C (95°F) ON ≤ 25°C (77°F) OFF	≥ 35°C (95°F) ON ≤ 25°C (77°F) OFF	≥ 35°C (95°F) ON ≤ 25°C (77°F) OFF	≥ 35°C (95°F) ON ≤ 25°C (77°F) OFF
Weather Rating	IP68	IP68	IP66	IP66
Vandal Proof	IK10 Impact Rated on Cast Aluminum Housing	IK10 Impact Rated on Cast Aluminum Housing	IK10 Impact Rated on Cast Aluminum Housing	IK10 Impact Rated on Cast Aluminum Housing
<b>Mechanical Specifications</b>				
Body Construction	Cast Aluminum	Cast Aluminum	Cast Aluminum	Cast Aluminum
Body & Sunshield Weight	2.8 kg (6.17 lb)	2.8 kg (6.17 lb)	2.9 kg (6.39 lb)	2.9 kg (6.39 lb)
Cable Grants	M16 x 4	M16 x 4	M16 x 4	M16 x 4

\* Inside camera specification must be within housing's operating temperature.

# Dimensions

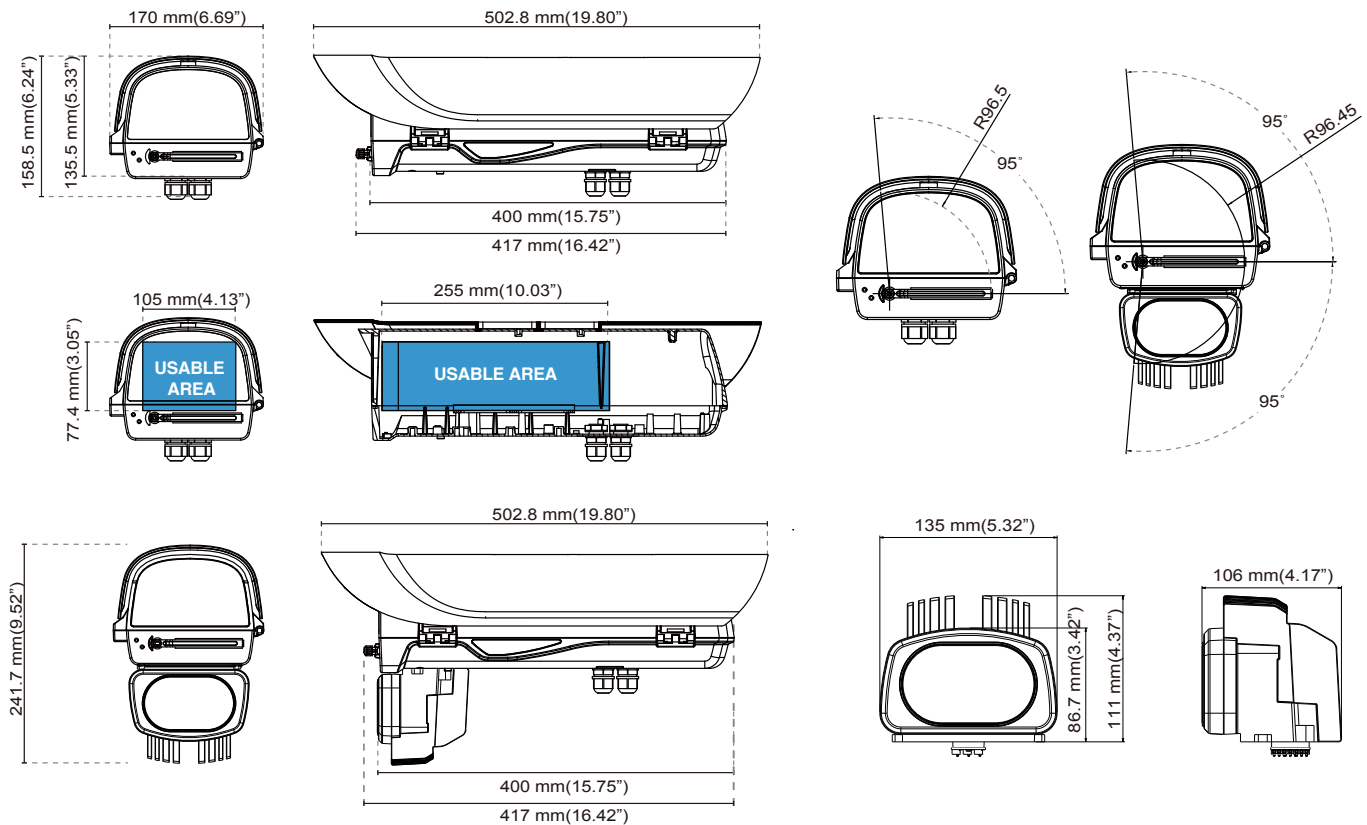





## P20 series Matrix Table











	24VAC in	PoE 30W in	PoE 30/60/95W in	Window Heater	Cold Start Heater (at -40°C)	Adjustable Sunshield	Blower	ITB for Optional 6W/12W/24W/48W VAIR IR	Side-Opening Alarm	Wiper	IP66	IP68
P2000-I	V	-	-	V	-	V	V	V	V	-	-	V
P2000-AI	V	-	-	V	V	V	V	V	V	-	-	V
P2000-IW	V	-	-	V	-	V	V	V	V	V	V	-
P2000-AIW	V	-	-	V	V	V	V	V	V	V	V	-

## Accessories

### Brackets

Wall Mount		Ceiling Mount		Standing Mount
				
<b>BK-101</b> Wall Mount Bracket Saftey Wire Concealing Cable	<b>BK-102</b> Wall Mount Bracket	<b>BK-200</b> J-type Ceiling Mount Bracket	<b>BK-201</b> Flexible J-type Ceiling Mount Bracket	<b>BK-300</b> Standing Mount Bracket

### Adapters

Pole Mount		Corner Mount	Fit	Wall Mount	Fit
					
<b>AT-100</b> Pole Mount Adapter	<b>AT-101</b> Pole Mount Adapter	<b>AT-200</b> Corner Mount Adapter	<b>BK-101</b>		
					
			<b>BK-102</b>		
					
				<b>JB-100</b> Junction Box	<b>AT-200</b>

### Junction Box

### Power Boxes

Outdoor Powe Box	Outdoor Power Box / Junction Box
	
<b>PB-024-1AC</b> Outdoor Power Box • IP67/IK10 • 115VAC / 230VAC Input • 24VAC/6A Output • -40°C ~ 60°C	<b>PB-024-2AC</b> Outdoor Power/Junction Box • IP67/IK10 • 115VAC / 230VAC Input • 24VAC/6A Output • -40°C ~ 60°C

### VAIR IR LEDs

VAIR IR LEDs		Water Tank & Pump
	<b>VR-060</b> • Snap Vair 10~40° IR LED, 6W  <b>VR 120</b> • Snap Vair 10~40° IR LED, 12W	
	<b>VR-240</b> • Snap Vair 10~40° IR LED, 24W  <b>VR-241</b> • Snap Vair 10~30° IR LED, 24W  <b>VR-480</b> • Snap Vair 10~40° IR LED, 48W  <b>VR-481</b> • Snap Vair 10~30° IR LED, 48W	
		<b>TP-100</b> • 10L Water Tank & Pump

### Water Tank & Pump