

Evolution 05 Mini 360° Indoor Camera

The next step in 360° total situational awareness

5 MP sensor and no moving parts

- Constant 360° surveillance with no blind spots
- No moving parts, no maintenance and silent operation
- Up to 30 fps video stream at 1 MP and ¼ MP
- 0.2 lux minimum illumination and electronic WDR
- PoE powered
- 3-years warranty

Advanced features

- microSD card slot for local event recording
- Configurable privacy regions
- Region-based motion detection

Multiple interior mount options

- Quick and easy installation
- Clean and simple design
- Convenient surface-mounting enclosure
- Range of accessories provide multiple mounting possibilities including ceiling, wall and pendant
- Enclosure available in Black and White

ONVIF | S



34458-102 - Black
34458-101 - White

Recording and Playback

- Market leading Oncam Grandeye 3D dewarping software
- Full live and retrospective dewarping available
- Simultaneous multiple video streams
- Digital zoom capability through client-side dewarping
- H.264 / MJPEG streaming with multiple quality levels
- Optimizes bandwidth and storage utilization
- Intuitive web-based interface for viewing and configuration
- ONVIF profile S conformant

Evolution 05 Mini 360° Indoor Camera

The next step in 360° total situational awareness

MODEL	34458-101 (WHITE)	34458-102 (BLACK)
GENERAL		
Lens Field of View	180° Horizontal, 168° Vertical	
Image Sensor	2592 H x 1944 V, 5 MP, 1/2.5-inch Sony CMOS Sensor	
Lens	185° / F2.0	
Minimum Illumination	0.2 lux = 50 IRE F/2.0 (6500 K)	
Frame Rate	30 fps for 1 MP and ¼ MP resolution 15 fps for 2 MP resolution 10 fps for 4 MP full resolution	
Video Motion Detection	8 configurable regions	
Security	Configurable password protection	
Advanced Event Management	Triggered by motion, HTTP event, result configurable, FTP/SNTP upload and local recording	
Networking	TCP/IP, HTTP, DHCP, DNS, NTP, FTP, SMTP, RTSP and uPNP	
Privacy Regions	10 configurable privacy regions	
MicroSD Card	Built-in microSD card slot. Supports cards up to 128 GB capacity. Speed class 10 or higher required	
White Balance Range	Auto White Balance (Range = approximately 2500 K - 8000 K)	
VIDEO		
Video Stream 1 Codec	H.264 High, Level 5 / MJPEG (streams configurable)	
Video Stream 1 Compression Level	Multi-levels of compression and frame rate adjustment	
Video Stream 1 Pixel Resolution	Fisheyes at: 4 MP (2144 x 1944), 2 MP (1488 x 1360), 1 MP (1056 x 960), ¼ MP (528 x 480)	
Video Stream 2 Codec	H.264 High, Level 5 / MJPEG (streams configurable)	
Video Stream 2 Compression Level	Multi-levels of compression and frame rate adjustment	
Video Stream 2 Pixel Resolution	Fisheyes at: 4 MP (2144 x 1944), 2 MP (1488 x 1360), 1 MP (1056 x 960), ¼ MP (528 x 480)	
Video Stream 3 Codec	MJPEG	
Video Stream 3 Compression Level	Multi-levels of compression and frame rate adjustment	
Video Stream 3 Pixel Resolution	Fisheye at: ¼ MP (528 x 480)	
Maximum Frame Rate	30 fps	
Image Control	Settings: brightness / contrast / saturation / exposure compensation, compression quality and wall / ceiling / table mount	
Image Enhancement	Electronic WDR 60dB	
PTZ Functionality	Zoom with Oncam 3D client-side dewarping software	
Web Browser Compatibility	Internet Explorer 9, Edge 25, Firefox 23 and Chrome 29 or above. Plug-in required for full functionality	
Unicast	Up to 20 simultaneous users depending on the resolution settings	
Multicast	Supported for H.264 main camera stream	
Bit Rate Control	Options include Variable Bit Rate Controls, Constant Bit Rate Control and Constant Quality Control	
ELECTRICAL		
Connection	Flying lead - RJ45 plug	
Network Cable Type	CAT5 or better for 100Base-TX	
Power Input	Power over Ethernet (PoE), IEEE standard 802.3af	
Power Consumption (maximum)	4.13 W	

Evolution 05 Mini 360° Indoor Camera

The next step in 360° total situational awareness

MECHANICAL

Camera Mount	Surface mount
Weight	0.22 kg (0.48 lbs)
Dimensions (Diameter x Depth)	107 x 34 mm (4.2 x 1.3 in.)
Housing Material	Polymer





ENVIRONMENTAL

Operating Temperature Range	0 to +40°C (-32 to +104°F)
Operating Humidity	Up to 98% non-condensing
Ingress Protection	IP40

CERTIFICATIONS

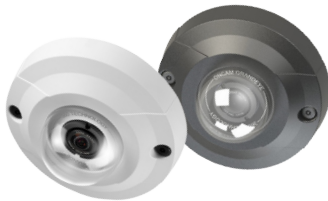
Approvals	IEEE802.3af, CE, AS/NZS CISPR 22:2009+A1:2010, CISPR 24:2010 (Class A), FCC, ICES-003, KCC, CU, RCM, SASO UL 60950-1(ed.2) & CAN/CSA C22.2 No. 60950-1-07, RoHS, REACH
-----------	--

ACCESSORIES

	PART NUMBER	DESCRIPTION
	34476 (White) 34475 (Black)	IK10+ vandal resistant bubble trim The bubble trim is made of optical grade polymer.
	34474 (White) 34473 (Black)	M20 conduit back box Fitted for the camera back and provides three entry points for easy cabling through M20 size conduits. Coil excess cable within back box.
	34477	Pendant Mount Adapter M32 female thread; supplied with M32 to 1½ NPT male thread adaptor. Fit onto the camera back.
	34479 (White) 34478 (Black)	Indoor Mounting Kit Includes a Pendant Mount Adapter and Conduit Back Box.

Evolution 05 Mini 360° Indoor Camera

The next step in 360° total situational awareness

ACCESSORIES (CONTINUED)

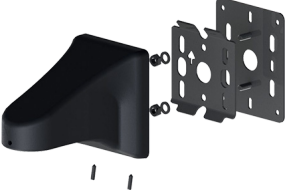
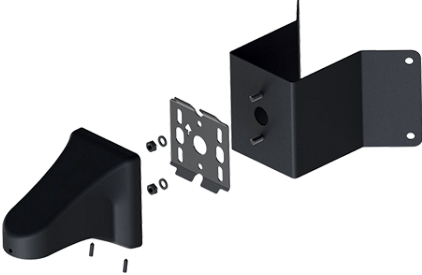
	PART NUMBER	DESCRIPTION
	34491 (White) 34490 (Black)	Pole Mount Bracket (Use with Pendant Mount)
	34493 (White) 34492 (Black)	Wall Mount Bracket (Use with Pendant Mount)
	34487 (White) 34486 (Black)	Corner Mount Bracket (Use with Pendant Mount)

DIMENSIONS

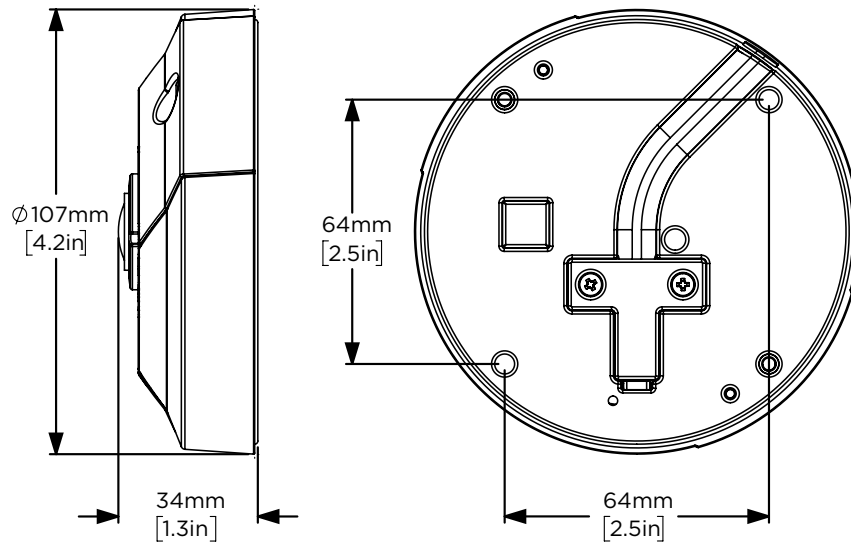

© Copyright 2014 - 2017 Oncam Global Group AG. All rights reserved.

Oncam Grandeye is the trade name of Oncam Global Group AG. Specifications and configurations subject to change without notice.

North America 1 800 563 5564
 Latin America +5255 5259 9511
 Europe +39 0362 17935
 Asia +65 6818 0963
 Australia and New Zealand +61 1300 089 419
 Middle East and Africa +971 4 399 5525

© 2018 March Networks. All rights reserved. Information in this document is subject to change without notice. MARCH NETWORKS, March Networks Command, March Networks Searchlight, March Networks RideSafe, and the MARCH NETWORKS logo are trademarks of March Networks Corporation. All other trademarks are the property of their respective owners. 060-3279-00-B
marchnetworks.com

