

A2100 A5100 A5100-E

Thermal Camera Housing

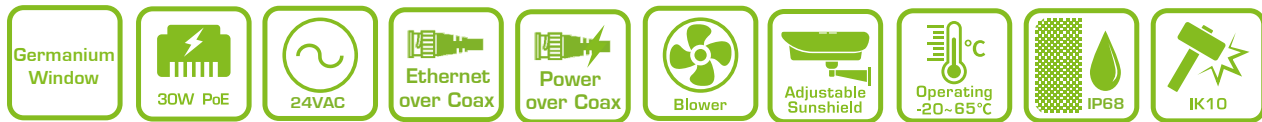

AETEK introduces the latest Thermal camera housings, integrating the Germanium glass for the specific Thermal cameras.

These camera housings are designed for the Thermal Imaging Cameras installation, being applied for various kind of applications, such as public safety, industrial monitoring, environment monitoring, military purposes, marine, and night vision security surveillance.

The camera housings can power via 30W PoE port or 24VAC based or long rang EPoC on the installation requirement.

Features

- Germanium window
- IP68 standard
- IK10 impact rated cast aluminum housing
- PoE surge protection(A5100)
- Blower support
- 24VAC input (A2100)
- 30W 802.3at PoE input (A5100)
- Long Range EPoC input (A5100-E)

Dimensions

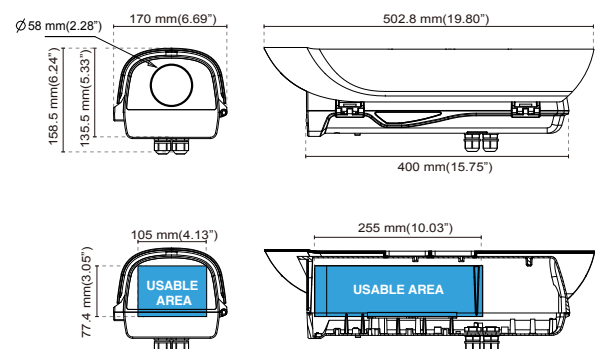

Matrix Table

	Germanium window	24VAC In	PoE 30W In	Long Range EPoC In	Cold Start Heater (at -40°C)	Adjustable Sunshield	Blower	Wiper	IP66	IP68
A2100	v	v	-	-	-	v	v	-	-	v
A5100	v	-	v	-	-	v	v	-	-	v
A5100-E	v	-	-	v	-	v	v	-	-	v

Specifications

	A2100	A5100	A5100-E
Electrical Specifications			
Input Voltage	24VAC	PoE at 50-57VDC	EPoC
Output Power Budget	48W	25 W thru 30W PoE PSE	20W @600m
12VDC Output Power Budget	30W	12W	12W
Camera Power Input	12VDC or 24VAC	PoE	PoE
Surge Protection	-	PoE Port : 6KV	BNC Port : 6KV
Power Consumption	Blower: 2W Camera: 6 ~ 8W	Blower: 2W Camera: 6 ~ 8W	Blower: 2W Camera: 6 ~ 8W
Housing's Window			
Window	Germanium window	Germanium window	Germanium window
Usable diameter	58mm (2.28in)	58mm (2.28in)	58mm (2.28in)
Thick	2mm (0.08in)	2mm (0.08in)	2mm (0.08in)
External treatment	antiscratch (Hard Carbon Coating - DLC), antireflection	antiscratch (Hard Carbon Coating - DLC), antireflection	antiscratch (Hard Carbon Coating - DLC), antireflection
Internal treatment	antireflection	antireflection	antireflection
Spectral range	from 7.5μm up to 14μm	from 7.5μm up to 14μm	from 7.5μm up to 14μm
Medium transmittance (from 7.5μm up to 11.5μm)	90%	90%	90%
Medium transmittance (from 11.5μm up to 14μm)	77%	77%	77%
Environmental Specifications			
Operating Temperature*	-20°C ~ 65°C (-4°F ~ 149°F)	-20°C ~ 65°C (-4°F ~ 149°F)	-20°C ~ 65°C (-4°F ~ 149°F)
Heater ON / OFF	<30°C (86°F) ON	≤ 30°C (86°F) ON ≥ 35°C (95°F) OFF	≤ 30°C (86°F) ON ≥ 35°C (95°F) OFF
Blower ON / OFF	>30°C (86°F) ON	≥ 40°C (104°F) ON ≤ 35°C (95°F) OFF	≥ 40°C (104°F) ON ≤ 35°C (95°F) OFF
Weather Rating	IP68	IP68	IP68
Vandal Proof	IK10 Impact Rated on Cast Aluminum Housing	IK10 Impact Rated on Cast Aluminum Housing	IK10 Impact Rated on Cast Aluminum Housing
Mechanical Specifications			
Body Material	Cast Aluminum	Cast Aluminum	Cast Aluminum
Body Weight	2.8 kg (6.18 lb)	2.8 kg (6.18 lb)	2.8 kg (6.18 lb)
Cable Grants	M16 x 4	M16 x 4	M16 x 4





* Inside camera specification must be within housing's operating temperature.

Accessories





Brackets

Wall Mount		Ceiling Mount		Standing Mount
				
BK-101 Wall Mount Bracket Safety Wire Concealing Cable	BK-102 Wall Mount Bracket	BK-200 J-type Ceiling Mount Bracket	BK-201 Flexible J-type Ceiling Mount Bracket	BK-300 Standing Mount Bracket

Adapters

Pole Mount		Corner Mount	Fit
			
AT-100 Pole Mount Adapter	AT-101 Pole Mount Adapter	AT-200 Corner Mount Adapter	BK-101
			
			BK-102



Junction Box

Wall Mount	Fit
	 BK-101
	 BK-102
	 AT-100
	 AT-101
	 AT-200

PoE Switches

Outdoor Unmanaged PoE Switch		Outdoor PoECam L2 Plus Managed Switch	
	H40-044-30-150 • 4xGbE PoE (30W) + 2xGbE SFP + 2xGbE RJ45 • 100-240VAC, 150W Power Budget		H80-044-30-150 • 4xGbE PoE (30W) + 2xGbE SFP + 2xGbE RJ45, 1xConsole, 1xDI/DO • 100-240VAC, 150W Power Budget
	H40-082-30-250 • 8xGbE PoE (30W) + 2xGbE SFP • 100-240VAC, 250W Power Budget		H80-084-30-250 • 8xGbE PoE (30W) + 4xGbE SFP, 1xConsole, 1xDI/DO • 100-240VAC, 250W Power Budget
	H40-044-60-250 • 4xGbE UPoE (60W) + 2xGbE SFP + 2xGbE RJ45 • 100-240VAC, 250W Power Budget		H80-044-30-250 • 4xGbE UPoE (60W) + 2xGbE SFP + 2xGbE RJ45, 1xConsole, 1xDI/DO • 100-240VAC, 250W Power Budget

EPoC RX Series

EPoC RX Adapter Series			
	XE10-110-RX • XE10-110 EPoC adapter(RX) • 65W@56VDC power adapter		XE11-110-RX • XE11-110 PoE EPoC adapter(RX) • Supports 30W/60W/95W PoE Input

EPoC RX Switch	
	XC10-041-250 • Four BNC coax ports & one LAN port • Playing RX mode • PoE pass through coax to remote PoE IP camera • 6KV Surge Protection for coax port • 250W Power Supply, 100-240VAC input • Back-up 56VDC power input • 19" Rack mount bracket

Accessories			
	CH-100 • 19", 1U 4-bay rack mount chassis • Works with XE10-110-RX & 65W power adapter		I36-100 • 60W UPoE Injector • works with XE11-110-RX
	CH-110 • 19", 1U 8-bay rack mount chassis • Works with XE11-110-RX		H30-044-90 • 60W/95W UPoE Switch • works with XE11-110-RX
	SD-301 • EPoC Surge Protector • 6KV Surge Protection		